

Varenummer: 204380M863D1S  
 Beskrivelse: E+G Justerfod  
 GN 43-80-M8-63-D1-S  
 Note: S Uden møtrik, udvendig sekskant i bunden

## Mål

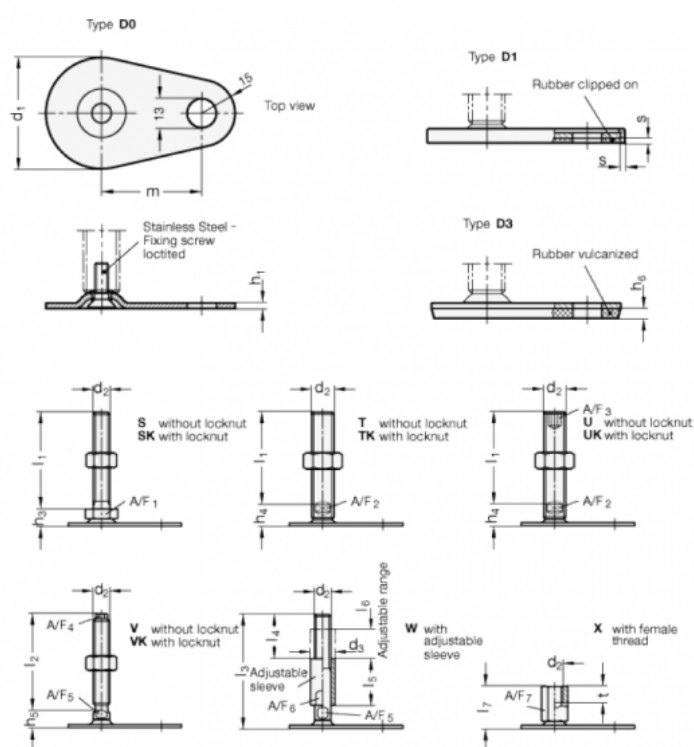

A/F1 = 17	s = 2
d1 = 80	
d2 = M8	
h1 = 3	
h3 = 12	
h6 =	
l1 = 63	
m = 70	